

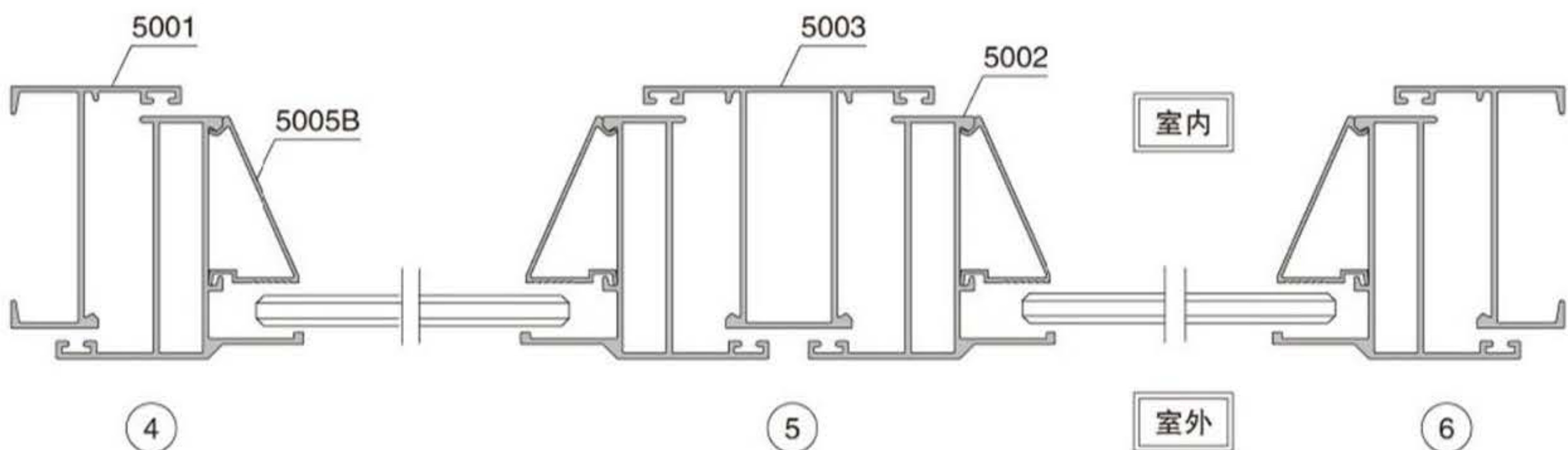

3801 窗框			3807 90度转角					
壁厚 (mm)	米重 (kg/m)		壁厚 (mm)	米重 (kg/m)		壁厚 (mm)	米重 (kg/m)	
1.2	0.34	0.9	0.560					
3801B 窗框								
壁厚 (mm)	米重 (kg/m)		壁厚 (mm)	米重 (kg/m)	壁厚 (mm)	米重 (kg/m)		
1.2	0.377							
3802 中挺								
壁厚 (mm)	米重 (kg/m)		壁厚 (mm)	米重 (kg/m)	壁厚 (mm)	米重 (kg/m)		
1.2	0.55							
3803 窗扇								
壁厚 (mm)	米重 (kg/m)		壁厚 (mm)	米重 (kg/m)	壁厚 (mm)	米重 (kg/m)		
1.2	0.46							
3804 框压线								
壁厚 (mm)	米重 (kg/m)		壁厚 (mm)	米重 (kg/m)	壁厚 (mm)	米重 (kg/m)		
0.8	0.136							
3805 扇压线								
壁厚 (mm)	米重 (kg/m)		壁厚 (mm)	米重 (kg/m)	壁厚 (mm)	米重 (kg/m)		
0.8	0.111							
3806 角码								
壁厚 (mm)	米重 (kg/m)		壁厚 (mm)	米重 (kg/m)	壁厚 (mm)	米重 (kg/m)		
-	0.78							

图样重量为基材理论重量，客户可根据需要的厚度订购，实际重量以过磅时的重量为准。

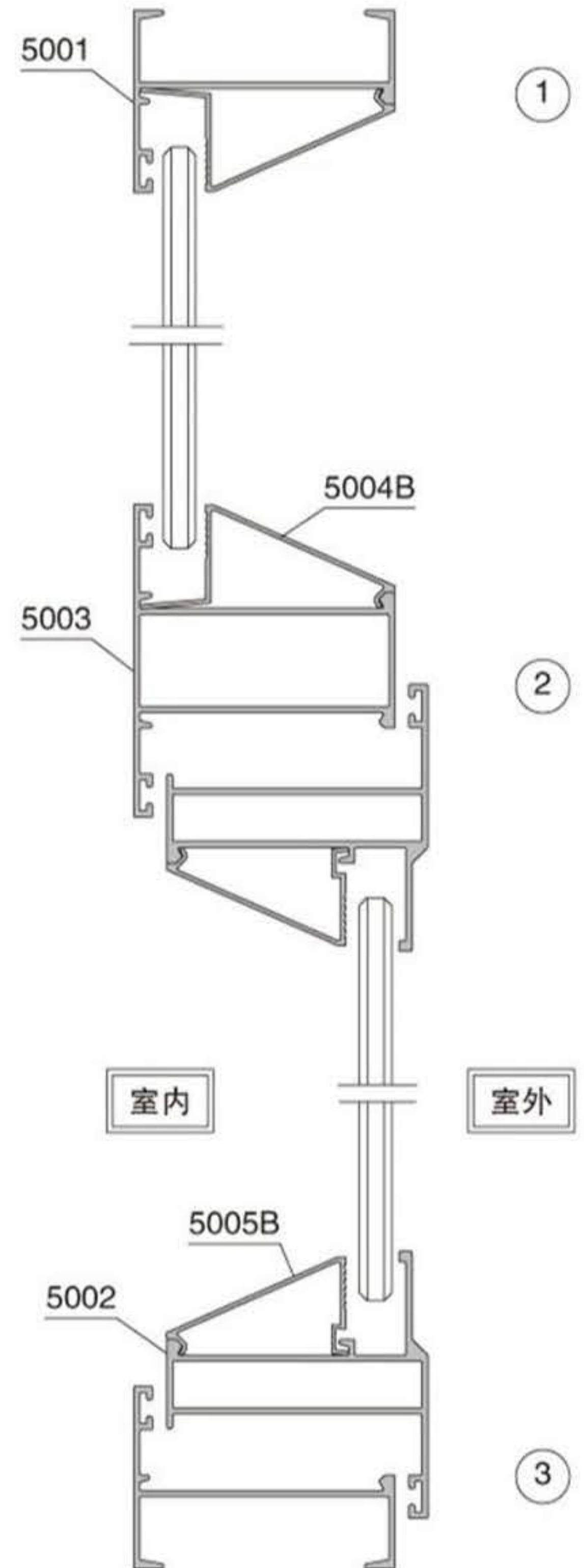
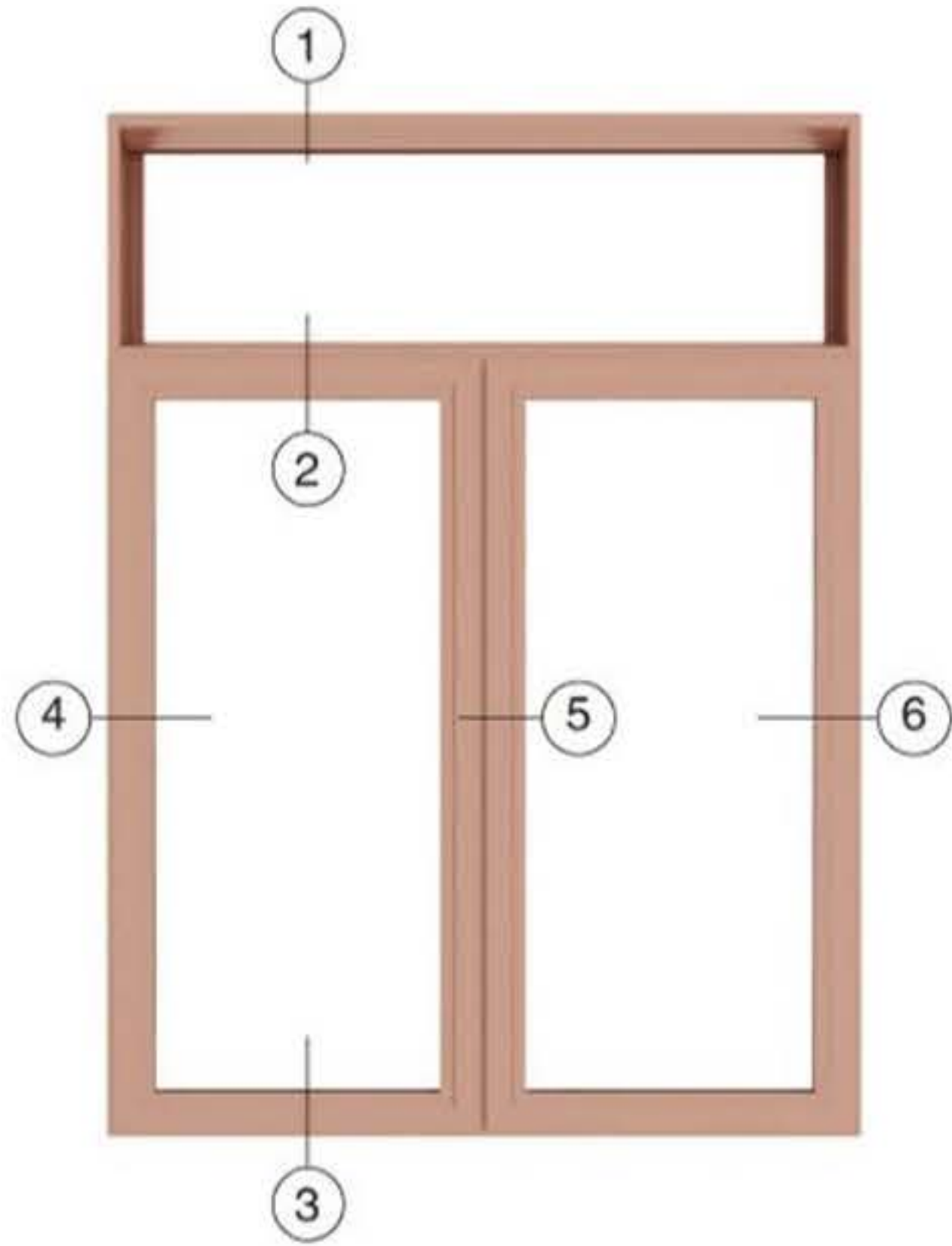

5001 窗框		5004 框压线		5009 转换框	
壁厚 (mm) 米重 (kg/m)		壁厚 (mm) 米重 (kg/m)		壁厚 (mm) 米重 (kg/m)	
1.2 0.388		0.8 0.173		1.2 0.36	
5001A 窗框		5004B 框压线		5012 拼管	
壁厚 (mm) 米重 (kg/m)		壁厚 (mm) 米重 (kg/m)		壁厚 (mm) 米重 (kg/m)	
1.4 0.586		0.8 0.172		1.2 0.45	
5001C 窗框		5005 扇压线		5014 框压线	
壁厚 (mm) 米重 (kg/m)		壁厚 (mm) 米重 (kg/m)		壁厚 (mm) 米重 (kg/m)	
1.2 0.47		0.8 0.142		0.8 0.175	
5002 窗扇		5005B 扇压线		5015 扇压线	
壁厚 (mm) 米重 (kg/m)		壁厚 (mm) 米重 (kg/m)		壁厚 (mm) 米重 (kg/m)	
1.2 0.581		0.8 0.146		0.8 0.143	
5002C 窗扇		5005C 扇压线			
壁厚 (mm) 米重 (kg/m)		壁厚 (mm) 米重 (kg/m)		壁厚 (mm) 米重 (kg/m)	
1.35 0.72		1.0 0.22			
5003 中挺		5006 转角			
壁厚 (mm) 米重 (kg/m)		壁厚 (mm) 米重 (kg/m)		壁厚 (mm) 米重 (kg/m)	
1.2 0.653		1.2 0.775			
5003C 中挺		5007 角码			
壁厚 (mm) 米重 (kg/m)		壁厚 (mm) 米重 (kg/m)		壁厚 (mm) 米重 (kg/m)	
1.2 0.71		- 1.58			

图样重量为基材理论重量，客户可根据需要的厚度订购，实际重量以过磅时的重量为准。

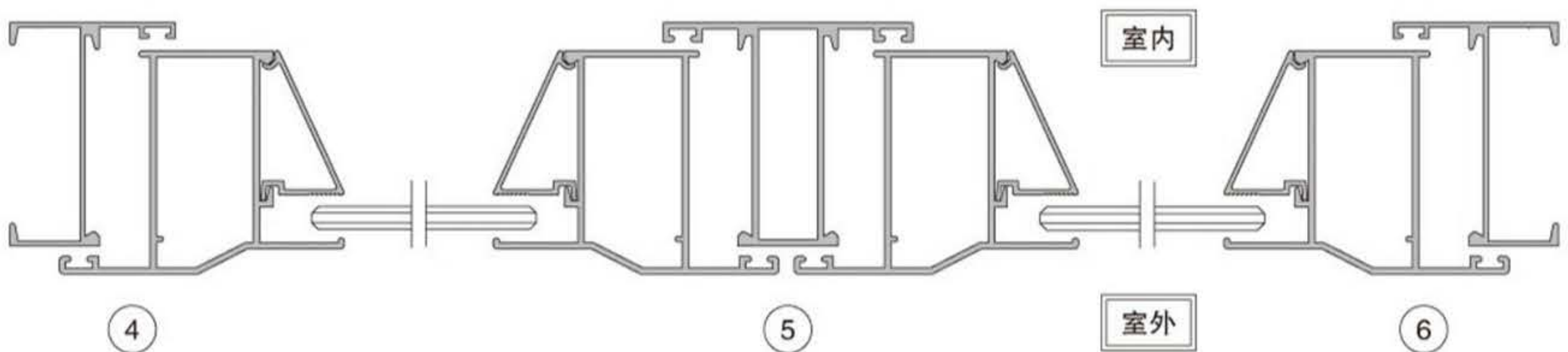
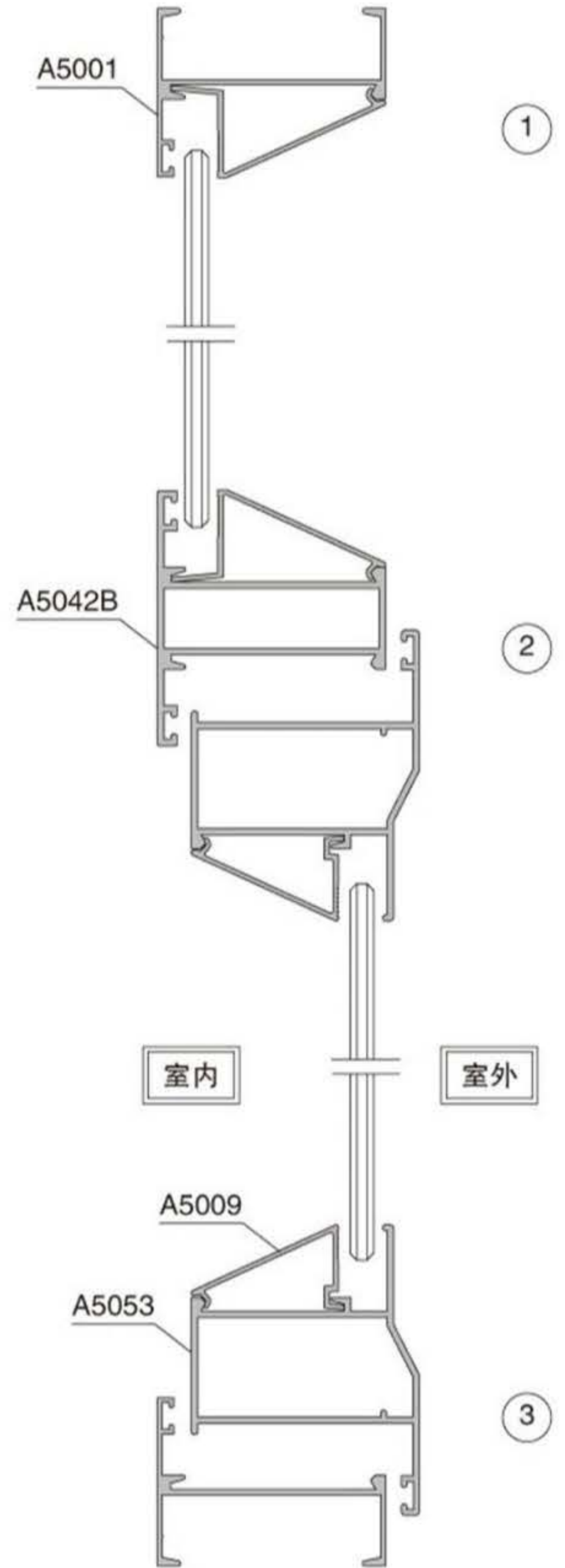
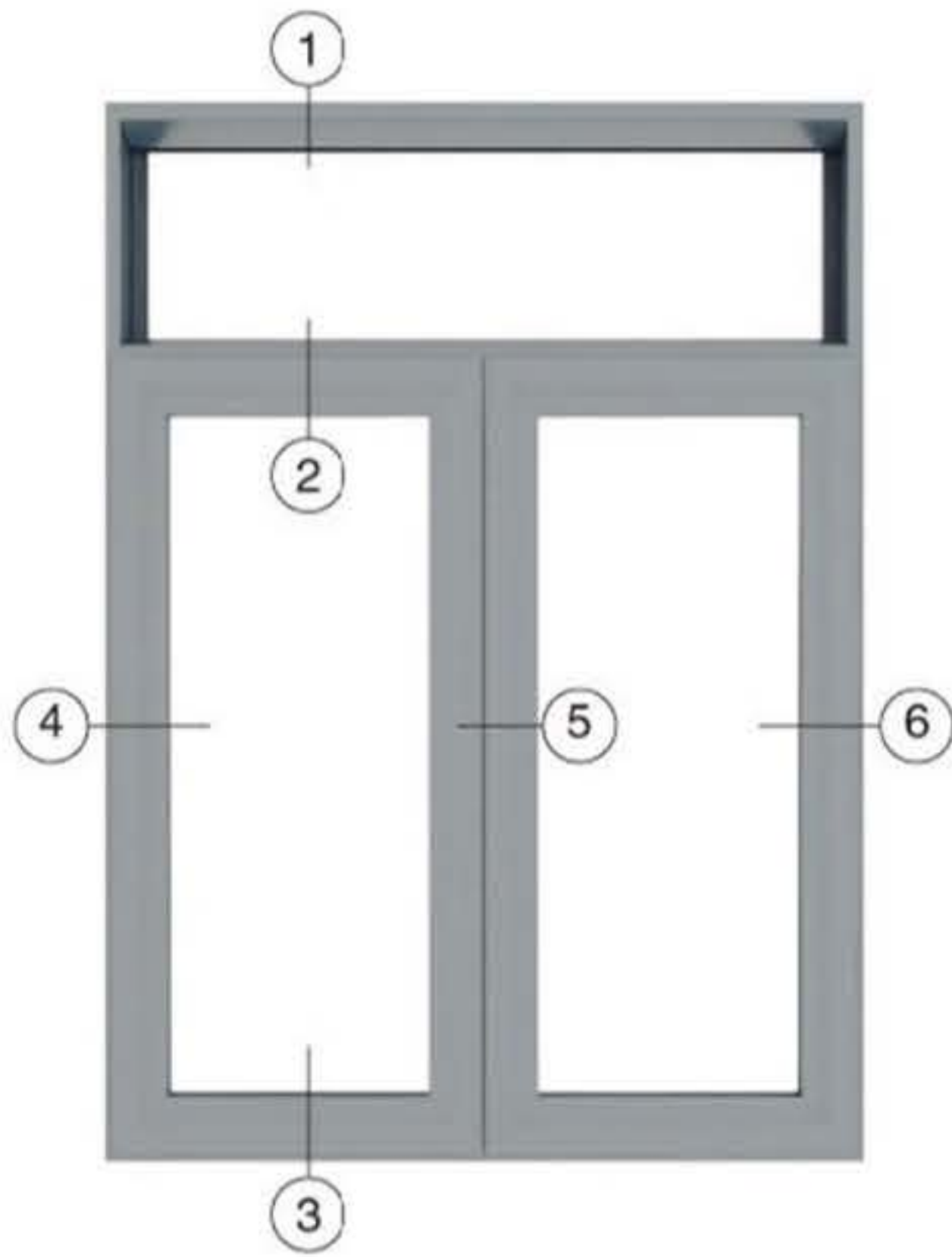

<p>A5001 窗框</p> <table border="1"> <tr> <th>壁厚 (mm)</th> <th>米重 (kg/m)</th> </tr> <tr> <td>1.4</td> <td>0.55</td> </tr> </table>	壁厚 (mm)	米重 (kg/m)	1.4	0.55	<p>A5007 转角</p> <table border="1"> <tr> <th>壁厚 (mm)</th> <th>米重 (kg/m)</th> </tr> <tr> <td>0.9</td> <td>0.53</td> </tr> </table>	壁厚 (mm)	米重 (kg/m)	0.9	0.53	<p>A5013B 扇压线</p> <table border="1"> <tr> <th>壁厚 (mm)</th> <th>米重 (kg/m)</th> </tr> <tr> <td>0.8</td> <td>0.173</td> </tr> </table> <p>只能配A5053B</p>	壁厚 (mm)	米重 (kg/m)	0.8	0.173
壁厚 (mm)	米重 (kg/m)													
1.4	0.55													
壁厚 (mm)	米重 (kg/m)													
0.9	0.53													
壁厚 (mm)	米重 (kg/m)													
0.8	0.173													
<p>A5001B 窗框</p> <table border="1"> <tr> <th>壁厚 (mm)</th> <th>米重 (kg/m)</th> </tr> <tr> <td>1.6</td> <td>0.99</td> </tr> </table>	壁厚 (mm)	米重 (kg/m)	1.6	0.99	<p>A5008 连接件</p> <table border="1"> <tr> <th>壁厚 (mm)</th> <th>米重 (kg/m)</th> </tr> <tr> <td>2.0</td> <td>0.36</td> </tr> </table>	壁厚 (mm)	米重 (kg/m)	2.0	0.36	<p>A5014 转换框</p> <table border="1"> <tr> <th>壁厚 (mm)</th> <th>米重 (kg/m)</th> </tr> <tr> <td>1.4</td> <td>0.45</td> </tr> </table>	壁厚 (mm)	米重 (kg/m)	1.4	0.45
壁厚 (mm)	米重 (kg/m)													
1.6	0.99													
壁厚 (mm)	米重 (kg/m)													
2.0	0.36													
壁厚 (mm)	米重 (kg/m)													
1.4	0.45													
<p>A5001Y 窗框</p> <table border="1"> <tr> <th>壁厚 (mm)</th> <th>米重 (kg/m)</th> </tr> <tr> <td>1.4</td> <td>0.602</td> </tr> </table>	壁厚 (mm)	米重 (kg/m)	1.4	0.602	<p>A5009 扇压线</p> <table border="1"> <tr> <th>壁厚 (mm)</th> <th>米重 (kg/m)</th> </tr> <tr> <td>1.0</td> <td>0.18</td> </tr> </table>	壁厚 (mm)	米重 (kg/m)	1.0	0.18	<p>A5031 窗框</p> <table border="1"> <tr> <th>壁厚 (mm)</th> <th>米重 (kg/m)</th> </tr> <tr> <td>1.4</td> <td>0.56</td> </tr> </table>	壁厚 (mm)	米重 (kg/m)	1.4	0.56
壁厚 (mm)	米重 (kg/m)													
1.4	0.602													
壁厚 (mm)	米重 (kg/m)													
1.0	0.18													
壁厚 (mm)	米重 (kg/m)													
1.4	0.56													
<p>A5002 窗扇</p> <table border="1"> <tr> <th>壁厚 (mm)</th> <th>米重 (kg/m)</th> </tr> <tr> <td>1.4</td> <td>0.69</td> </tr> </table>	壁厚 (mm)	米重 (kg/m)	1.4	0.69	<p>A5010 转角</p> <table border="1"> <tr> <th>壁厚 (mm)</th> <th>米重 (kg/m)</th> </tr> <tr> <td>1.4</td> <td>0.93</td> </tr> </table>	壁厚 (mm)	米重 (kg/m)	1.4	0.93	<p>A5035 框压线</p> <table border="1"> <tr> <th>壁厚 (mm)</th> <th>米重 (kg/m)</th> </tr> <tr> <td>1.0</td> <td>0.202</td> </tr> </table>	壁厚 (mm)	米重 (kg/m)	1.0	0.202
壁厚 (mm)	米重 (kg/m)													
1.4	0.69													
壁厚 (mm)	米重 (kg/m)													
1.4	0.93													
壁厚 (mm)	米重 (kg/m)													
1.0	0.202													
<p>A5002B 窗扇</p> <table border="1"> <tr> <th>壁厚 (mm)</th> <th>米重 (kg/m)</th> </tr> <tr> <td>2.0</td> <td>1.25</td> </tr> </table>	壁厚 (mm)	米重 (kg/m)	2.0	1.25	<p>A5011 框压线</p> <table border="1"> <tr> <th>壁厚 (mm)</th> <th>米重 (kg/m)</th> </tr> <tr> <td>1.0</td> <td>0.21</td> </tr> </table>	壁厚 (mm)	米重 (kg/m)	1.0	0.21	<p>A5035B 扇压线</p> <table border="1"> <tr> <th>壁厚 (mm)</th> <th>米重 (kg/m)</th> </tr> <tr> <td>1.0</td> <td>0.163</td> </tr> </table>	壁厚 (mm)	米重 (kg/m)	1.0	0.163
壁厚 (mm)	米重 (kg/m)													
2.0	1.25													
壁厚 (mm)	米重 (kg/m)													
1.0	0.21													
壁厚 (mm)	米重 (kg/m)													
1.0	0.163													
<p>A5005 中挺</p> <table border="1"> <tr> <th>壁厚 (mm)</th> <th>米重 (kg/m)</th> </tr> <tr> <td>1.4</td> <td>0.9</td> </tr> </table>	壁厚 (mm)	米重 (kg/m)	1.4	0.9	<p>A5012 加强中挺</p> <table border="1"> <tr> <th>壁厚 (mm)</th> <th>米重 (kg/m)</th> </tr> <tr> <td>2.0</td> <td>1.95</td> </tr> </table>	壁厚 (mm)	米重 (kg/m)	2.0	1.95	<p>A5042 中挺</p> <table border="1"> <tr> <th>壁厚 (mm)</th> <th>米重 (kg/m)</th> </tr> <tr> <td>1.4</td> <td>0.86</td> </tr> </table>	壁厚 (mm)	米重 (kg/m)	1.4	0.86
壁厚 (mm)	米重 (kg/m)													
1.4	0.9													
壁厚 (mm)	米重 (kg/m)													
2.0	1.95													
壁厚 (mm)	米重 (kg/m)													
1.4	0.86													
<p>A5006 角码</p> <table border="1"> <tr> <th>壁厚 (mm)</th> <th>米重 (kg/m)</th> </tr> <tr> <td>3.5</td> <td>2.4</td> </tr> </table>	壁厚 (mm)	米重 (kg/m)	3.5	2.4	<p>A5013A 扇压线</p> <table border="1"> <tr> <th>壁厚 (mm)</th> <th>米重 (kg/m)</th> </tr> <tr> <td>1.6</td> <td>0.99</td> </tr> </table>	壁厚 (mm)	米重 (kg/m)	1.6	0.99	<p>A5042B 中挺</p> <table border="1"> <tr> <th>壁厚 (mm)</th> <th>米重 (kg/m)</th> </tr> <tr> <td>1.4</td> <td>0.79</td> </tr> </table>	壁厚 (mm)	米重 (kg/m)	1.4	0.79
壁厚 (mm)	米重 (kg/m)													
3.5	2.4													
壁厚 (mm)	米重 (kg/m)													
1.6	0.99													
壁厚 (mm)	米重 (kg/m)													
1.4	0.79													

图样重量为基材理论重量，客户可根据需要的厚度订购，实际重量以过磅时的重量为准。

A5045 框压线						
壁厚 (mm)	米重 (kg/m)		壁厚 (mm)	米重 (kg/m)	壁厚 (mm)	米重 (kg/m)
1.0	0.24					
A5045B 框压线						
壁厚 (mm)	米重 (kg/m)		壁厚 (mm)	米重 (kg/m)	壁厚 (mm)	米重 (kg/m)
0.8	0.19					
A5053 窗扇						
壁厚 (mm)	米重 (kg/m)		壁厚 (mm)	米重 (kg/m)	壁厚 (mm)	米重 (kg/m)
1.4	0.76					
A5053B 窗扇						
壁厚 (mm)	米重 (kg/m)		壁厚 (mm)	米重 (kg/m)	壁厚 (mm)	米重 (kg/m)
1.4	0.761					
壁厚 (mm)	米重 (kg/m)	壁厚 (mm)	米重 (kg/m)	壁厚 (mm)	米重 (kg/m)	
壁厚 (mm)	米重 (kg/m)	壁厚 (mm)	米重 (kg/m)	壁厚 (mm)	米重 (kg/m)	
壁厚 (mm)	米重 (kg/m)	壁厚 (mm)	米重 (kg/m)	壁厚 (mm)	米重 (kg/m)	

图样重量为基材理论重量，客户可根据需要的厚度订购，实际重量以过磅时的重量为准。

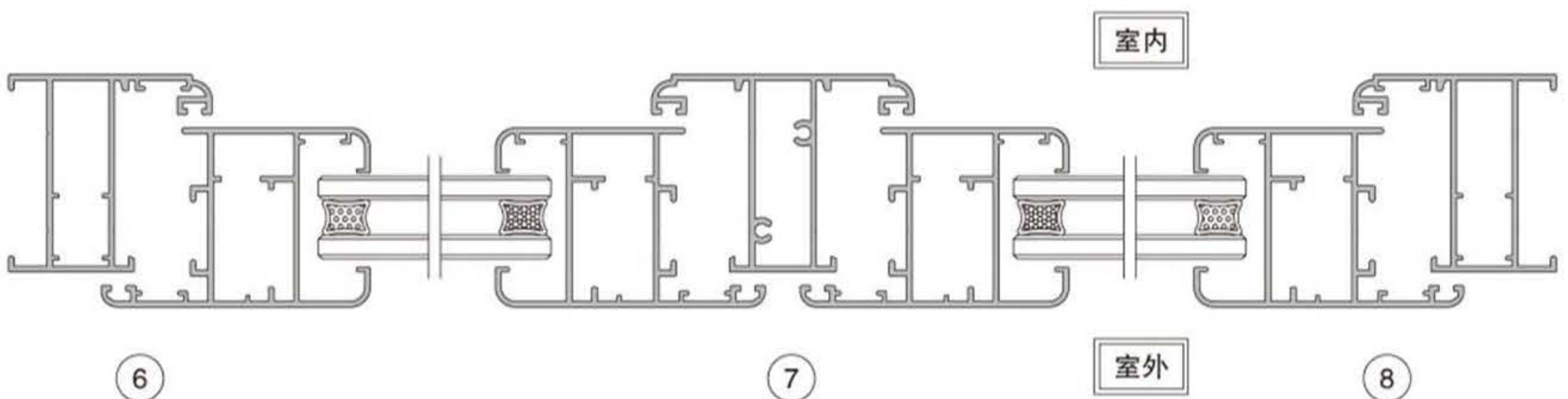
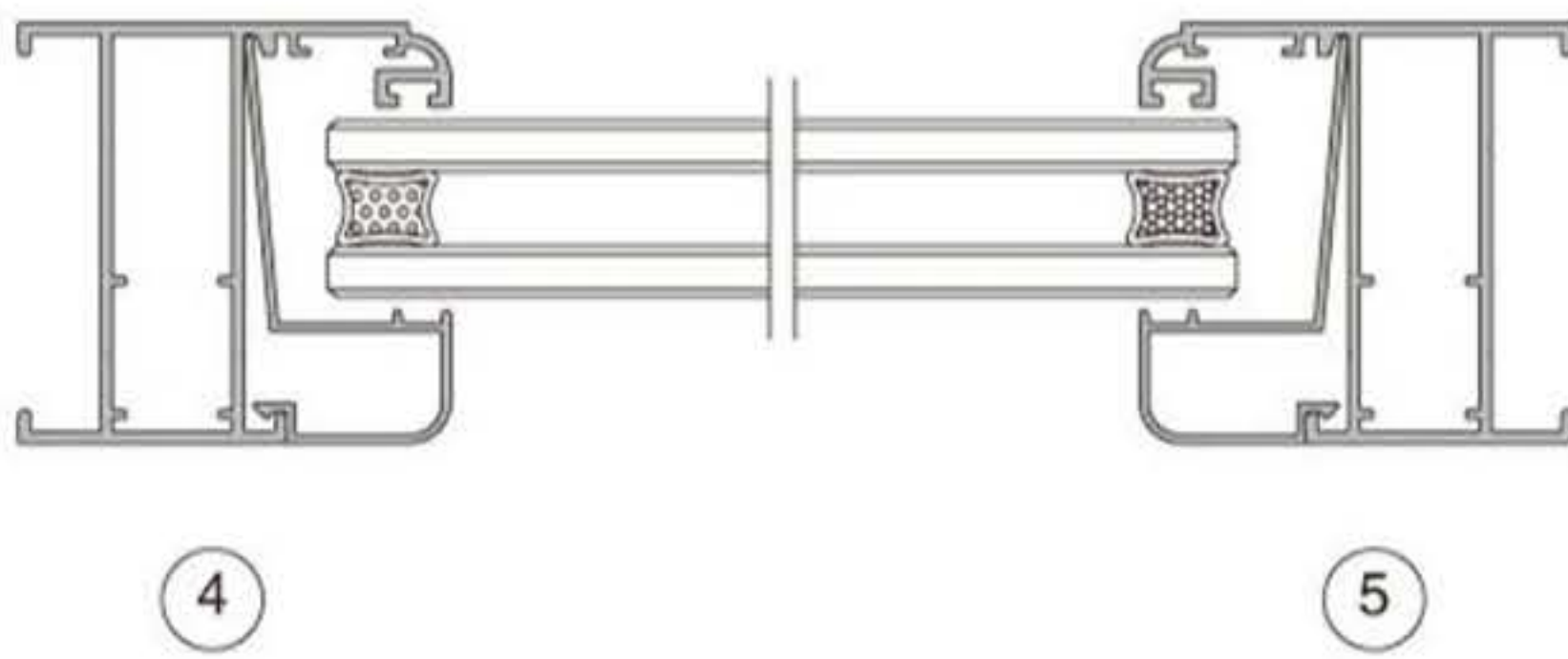
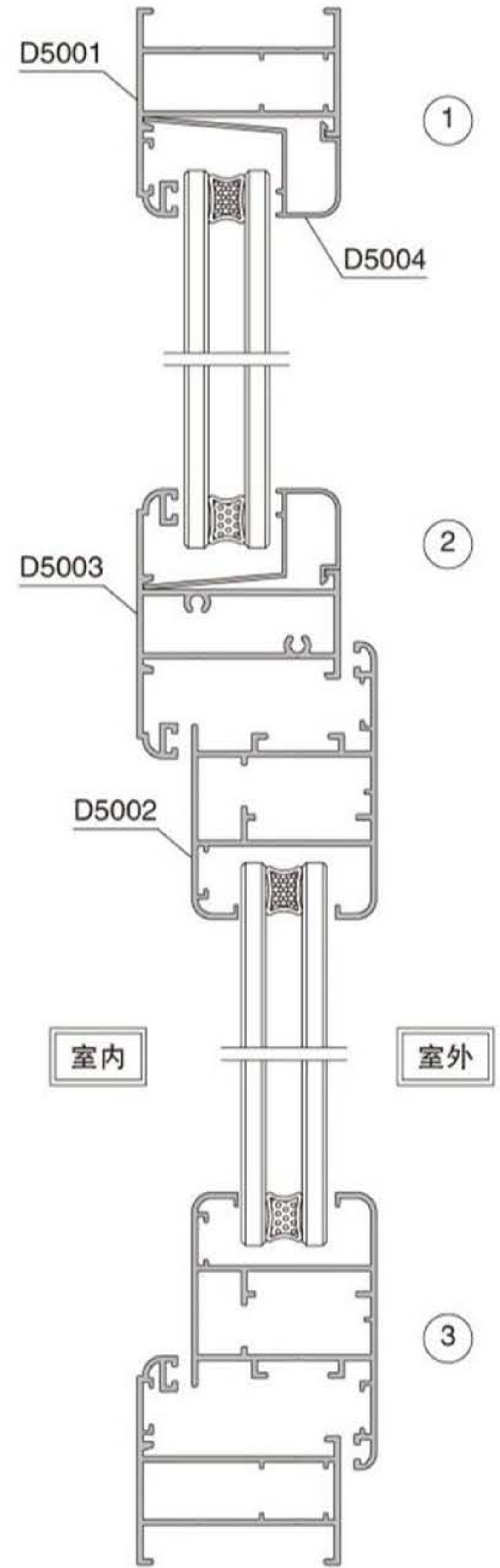
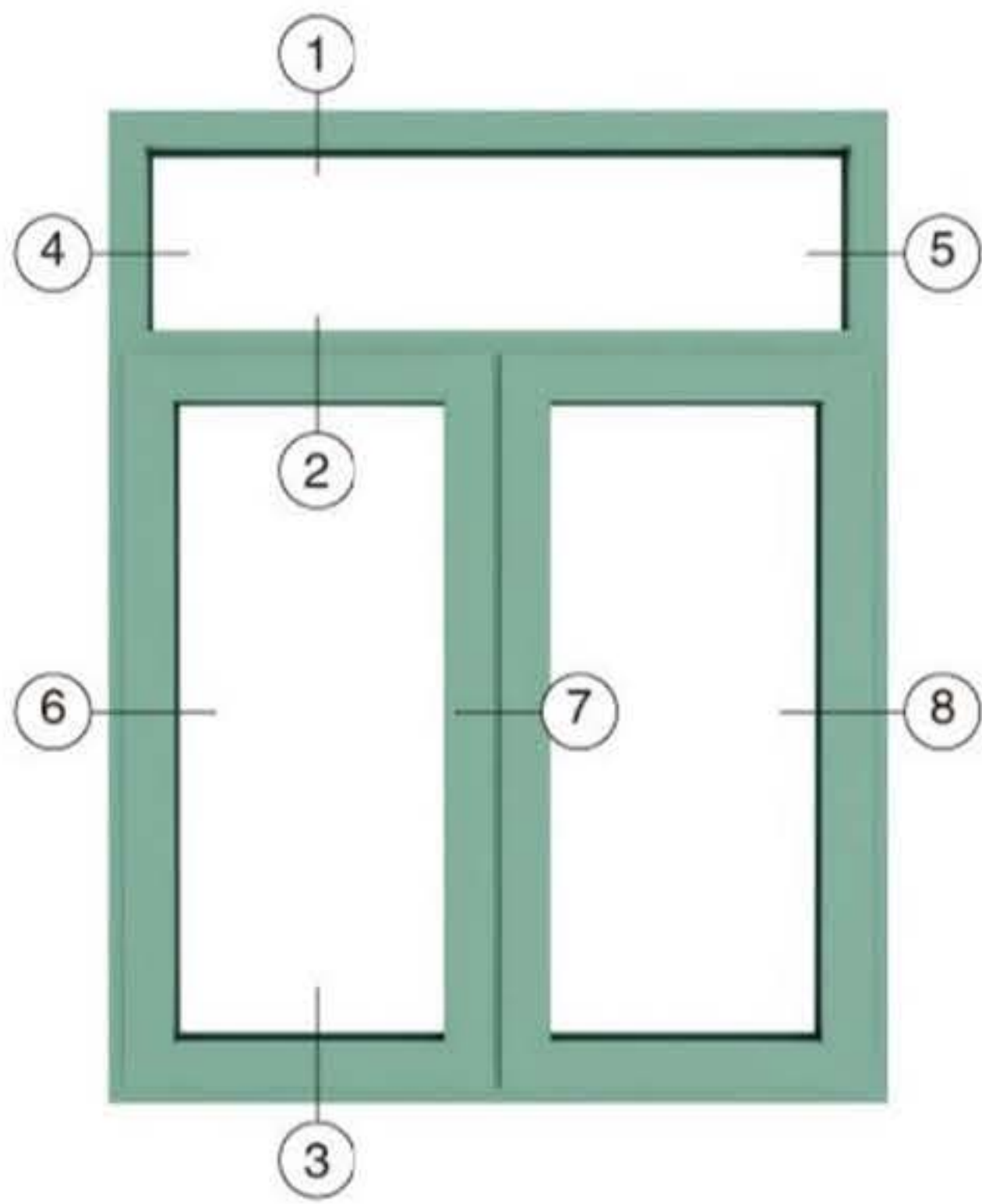





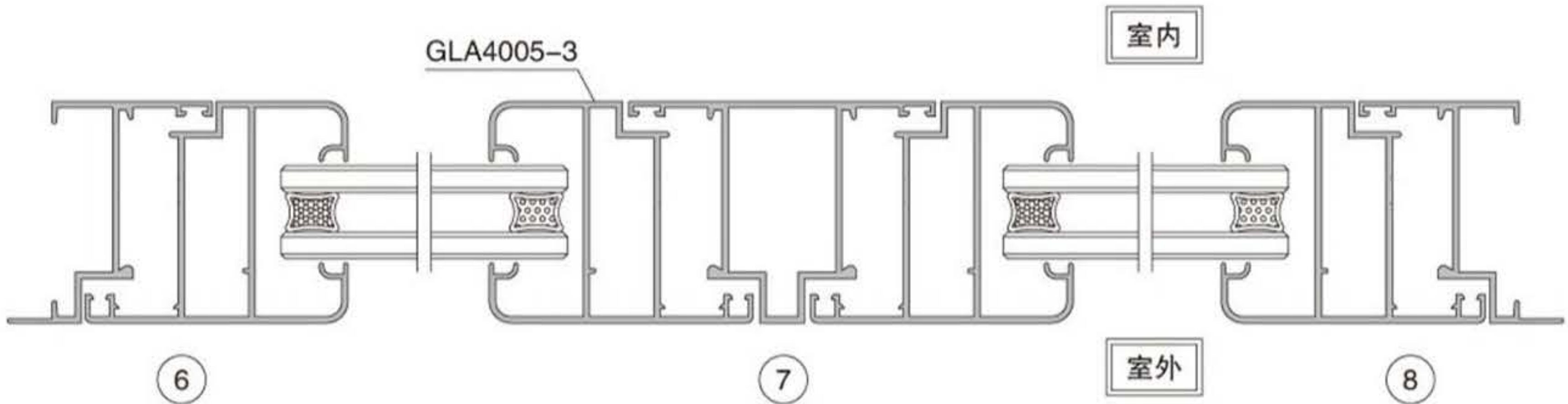
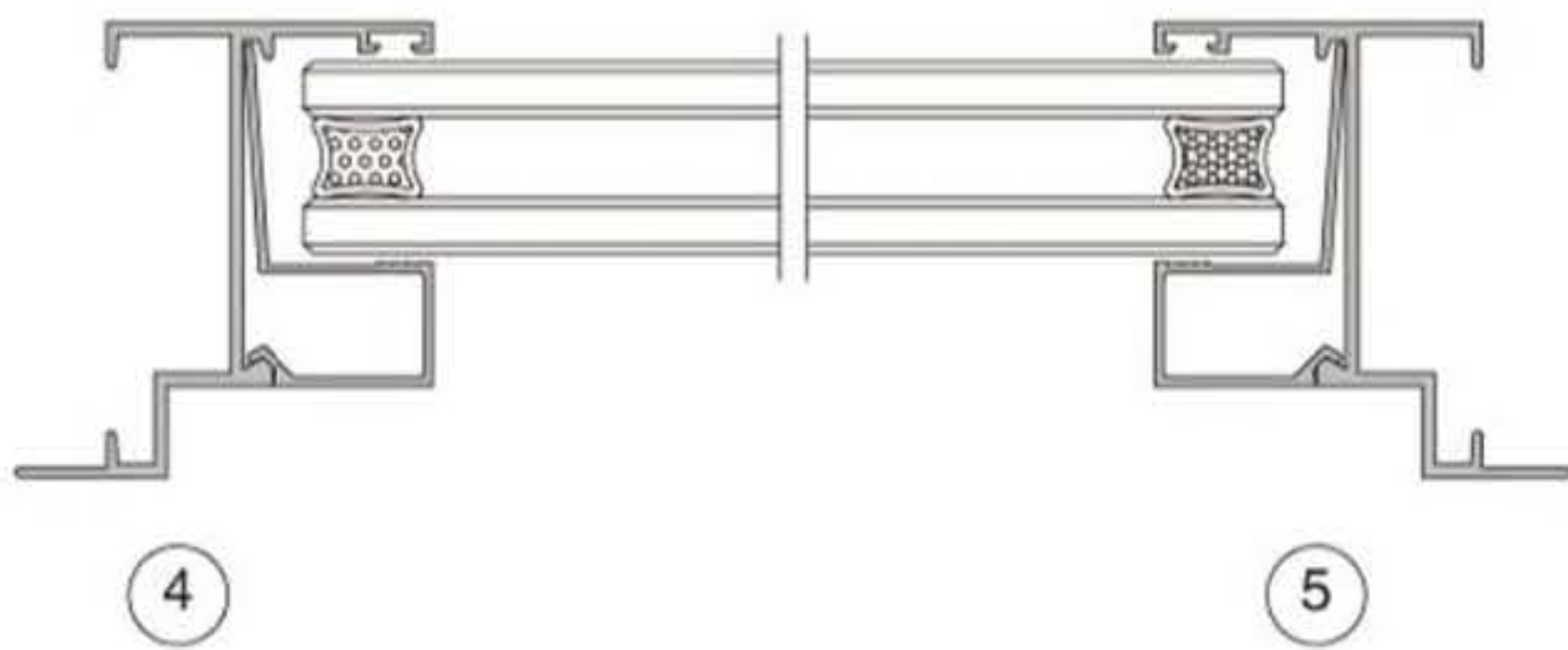
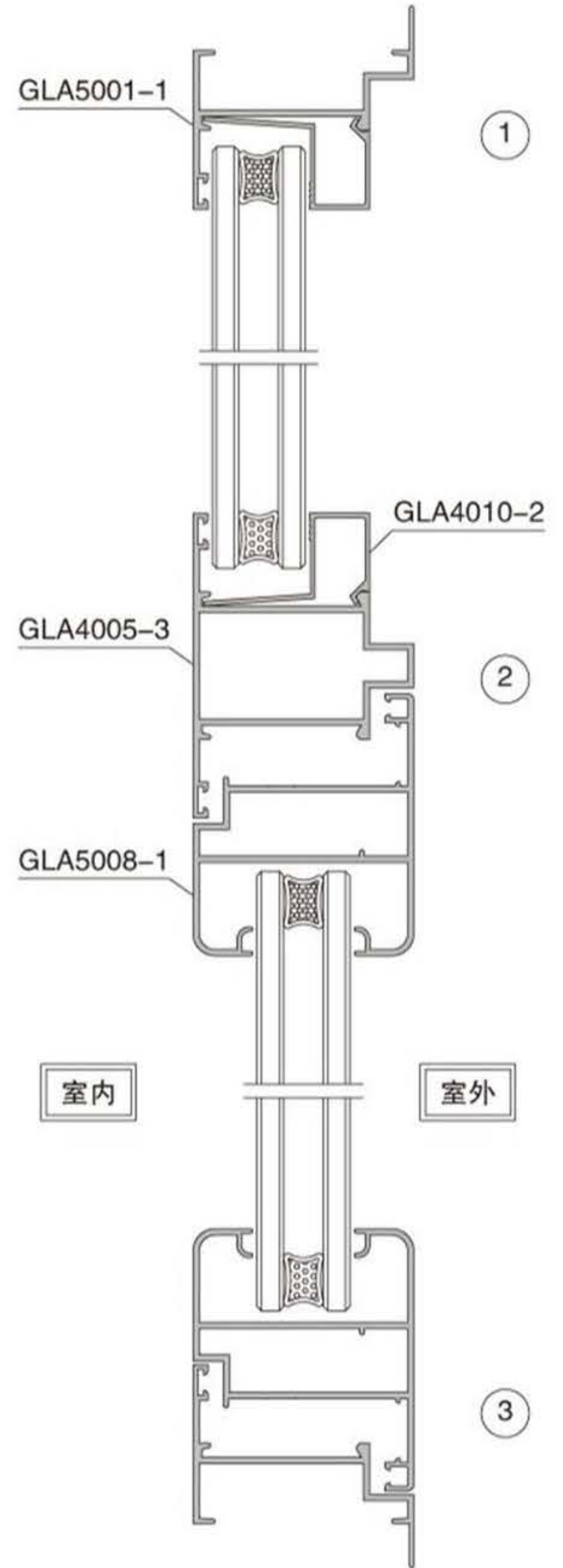
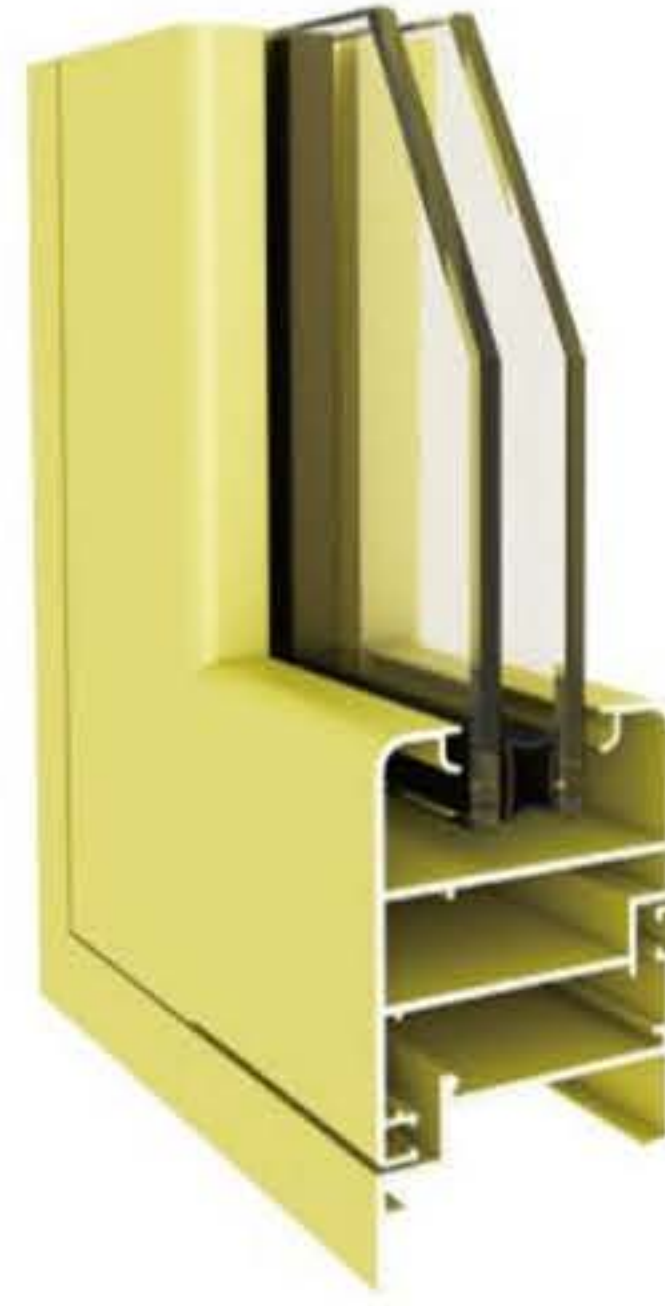
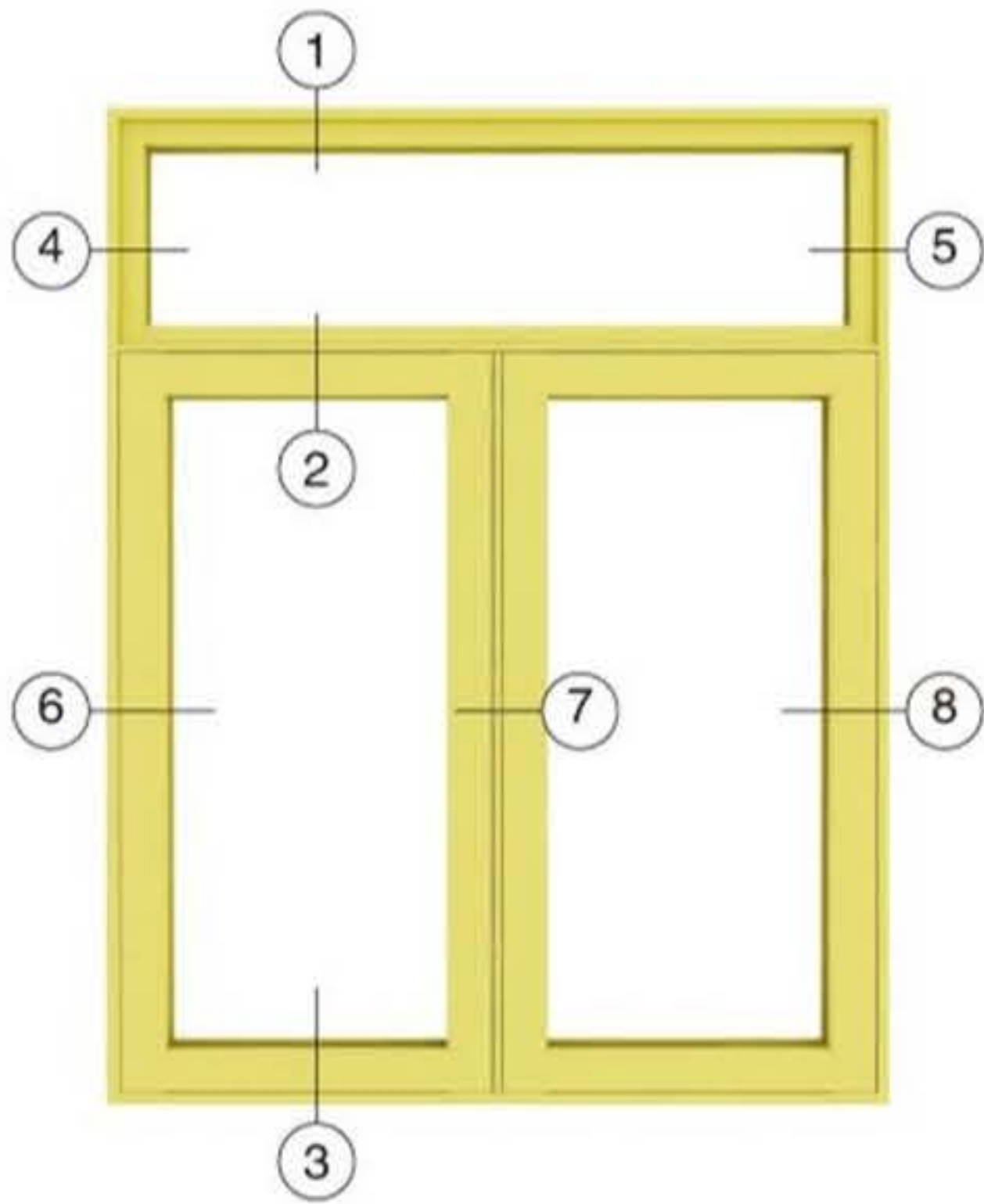

D5001 窗框						
壁厚 (mm)	米重 (kg/m)		壁厚 (mm)	米重 (kg/m)	壁厚 (mm)	米重 (kg/m)
1.4	0.825					
D5002 窗扇						
壁厚 (mm)	米重 (kg/m)		壁厚 (mm)	米重 (kg/m)	壁厚 (mm)	米重 (kg/m)
1.4	1.01					
D5003 中挺						
壁厚 (mm)	米重 (kg/m)		壁厚 (mm)	米重 (kg/m)	壁厚 (mm)	米重 (kg/m)
1.4	0.98					
D5004 压线						
壁厚 (mm)	米重 (kg/m)		壁厚 (mm)	米重 (kg/m)	壁厚 (mm)	米重 (kg/m)
1.0	0.26					
D5005 转换框						
壁厚 (mm)	米重 (kg/m)		壁厚 (mm)	米重 (kg/m)	壁厚 (mm)	米重 (kg/m)
1.4	0.64					
壁厚 (mm)	米重 (kg/m)		壁厚 (mm)	米重 (kg/m)	壁厚 (mm)	米重 (kg/m)
壁厚 (mm)	米重 (kg/m)		壁厚 (mm)	米重 (kg/m)	壁厚 (mm)	米重 (kg/m)

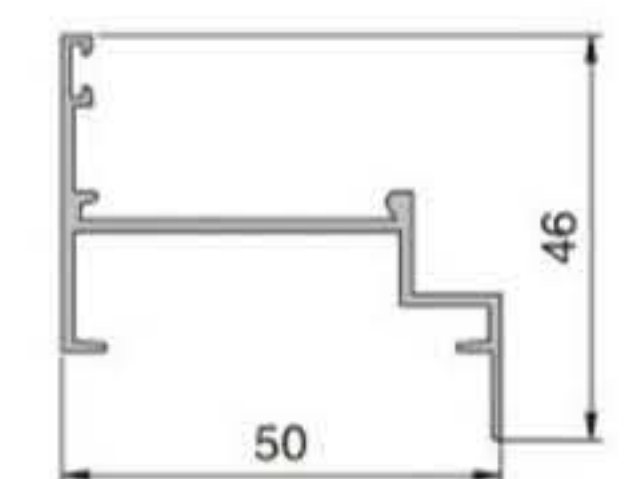
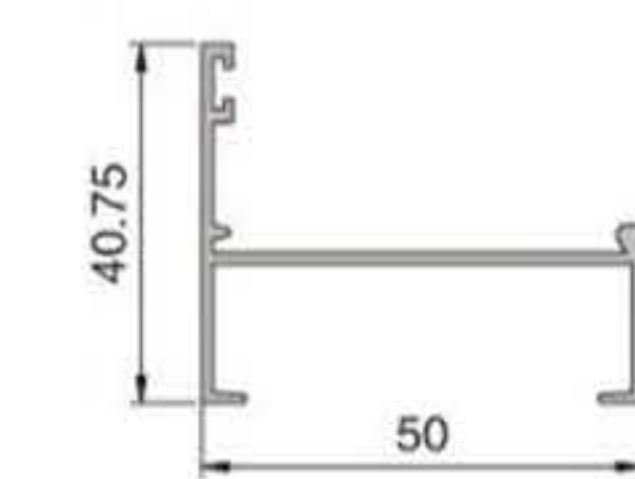
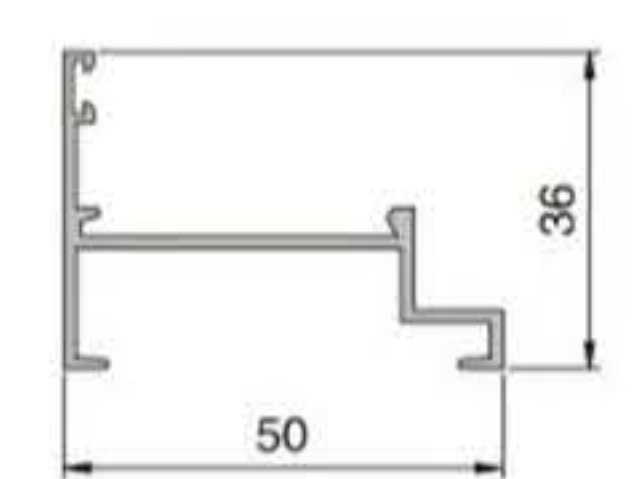
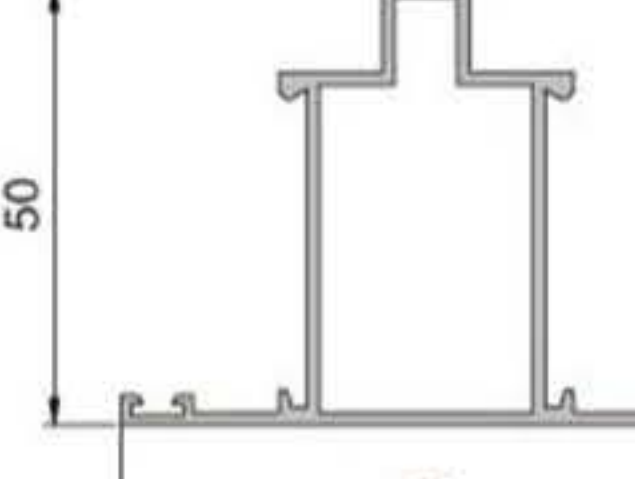
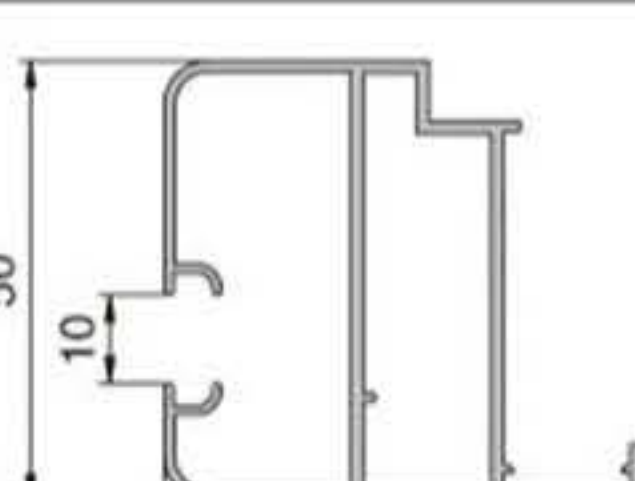
图样重量为基材理论重量，客户可根据需要的厚度订购，实际重量以过磅时的重量为准。

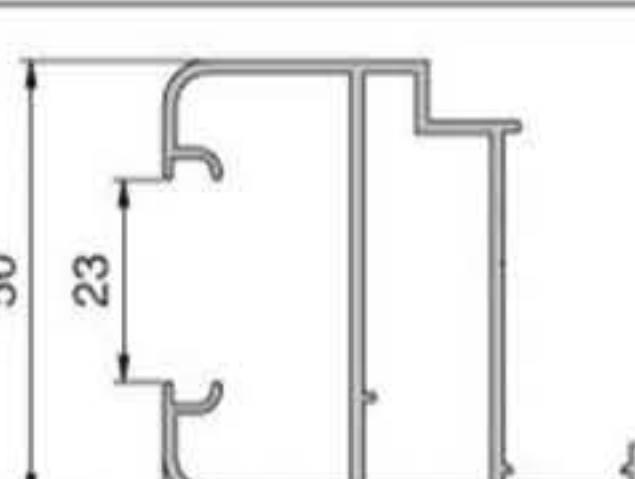

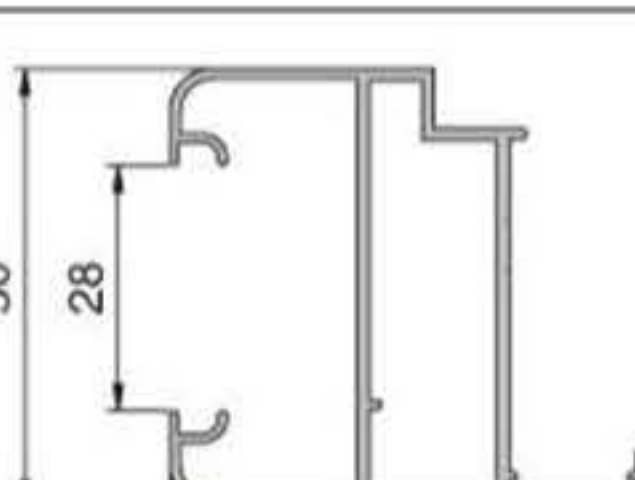
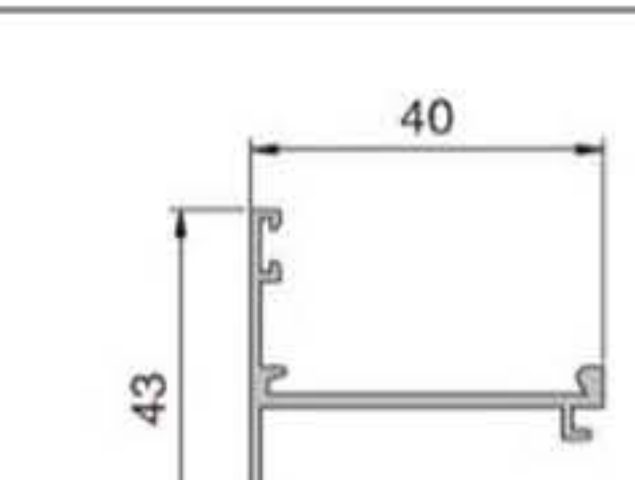
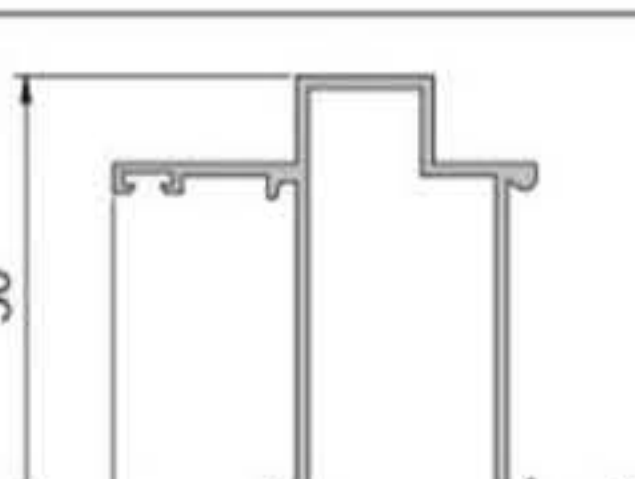
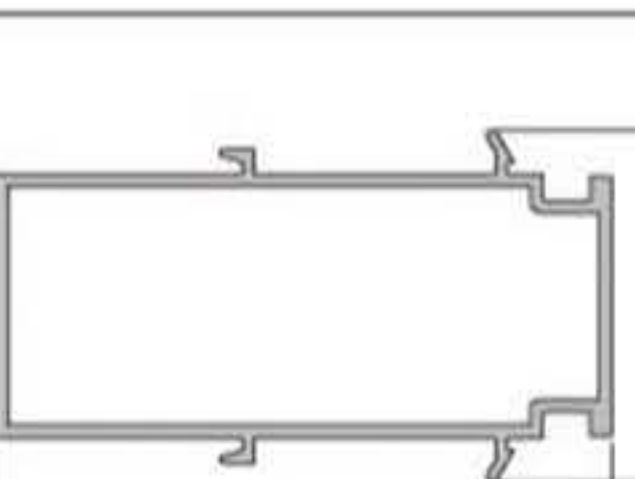
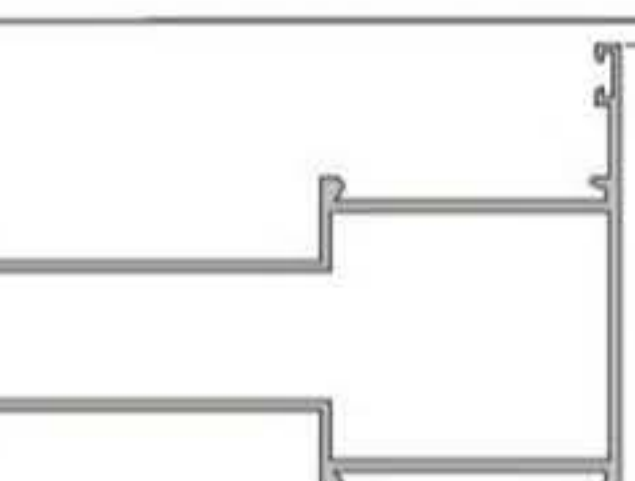
<p>GLA5001-1 窗框</p> <p>壁厚 (mm) 米重 (kg/m)</p> <p>1.4 0.48</p> 	<p>GLA5041 窗框</p> <p>壁厚 (mm) 米重 (kg/m)</p> <p>1.2 0.432</p> 		
<p>GLA5001-5 窗框</p> <p>壁厚 (mm) 米重 (kg/m)</p> <p>1.4 0.452</p> 	<p>GLA4005-3 中挺</p> <p>壁厚 (mm) 米重 (kg/m)</p> <p>1.4 0.84</p> 		
<p>GLA5008 窗扇</p> <p>壁厚 (mm) 米重 (kg/m)</p> <p>1.4 0.92</p> 	<p>GLA4008-2 压线</p> <p>壁厚 (mm) 米重 (kg/m)</p> <p>1.0 0.24</p> 		
<p>GLA5008-1 窗扇</p> <p>壁厚 (mm) 米重 (kg/m)</p> <p>1.4 0.91</p> 	<p>GLA4010-2 框压线</p> <p>壁厚 (mm) 米重 (kg/m)</p> <p>1.0 0.21</p> 		
<p>GLA5008-3 窗扇</p> <p>壁厚 (mm) 米重 (kg/m)</p> <p>1.4 0.863</p> 	<p>GLA4011-1 转换框</p> <p>壁厚 (mm) 米重 (kg/m)</p> <p>1.2 0.373</p> 		
<p>GLA5009 转换中挺</p> <p>壁厚 (mm) 米重 (kg/m)</p> <p>1.4 0.815</p> 	<p>GLA4017 拼管</p> <p>壁厚 (mm) 米重 (kg/m)</p> <p>1.45 0.89</p> 		
<p>GLA5009-1 中挺</p> <p>壁厚 (mm) 米重 (kg/m)</p> <p>1.4 1.27</p> 			

图样重量为基材理论重量，客户可根据需要的厚度订购，实际重量以过磅时的重量为准。