

11003 套芯						
壁厚 (mm)	米重 (kg/m)		壁厚 (mm)	米重 (kg/m)	壁厚 (mm)	米重 (kg/m)
3.0	2.04					
11004 立柱						
壁厚 (mm)	米重 (kg/m)		壁厚 (mm)	米重 (kg/m)	壁厚 (mm)	米重 (kg/m)
3.0	2.5					
11006 横梁						
壁厚 (mm)	米重 (kg/m)		壁厚 (mm)	米重 (kg/m)	壁厚 (mm)	米重 (kg/m)
2.0	0.990					
11007 横梁盖板						
壁厚 (mm)	米重 (kg/m)		壁厚 (mm)	米重 (kg/m)	壁厚 (mm)	米重 (kg/m)
1.0	0.222					
11008 装饰盖						
壁厚 (mm)	米重 (kg/m)		壁厚 (mm)	米重 (kg/m)	壁厚 (mm)	米重 (kg/m)
1.5	0.377					
11009 压块						
壁厚 (mm)	米重 (kg/m)		壁厚 (mm)	米重 (kg/m)	壁厚 (mm)	米重 (kg/m)
-	0.455					
壁厚 (mm)	米重 (kg/m)	壁厚 (mm)	米重 (kg/m)	壁厚 (mm)	米重 (kg/m)	

图样重量为基材理论重量，客户可根据需要的厚度订购，实际重量以过磅时的重量为准。

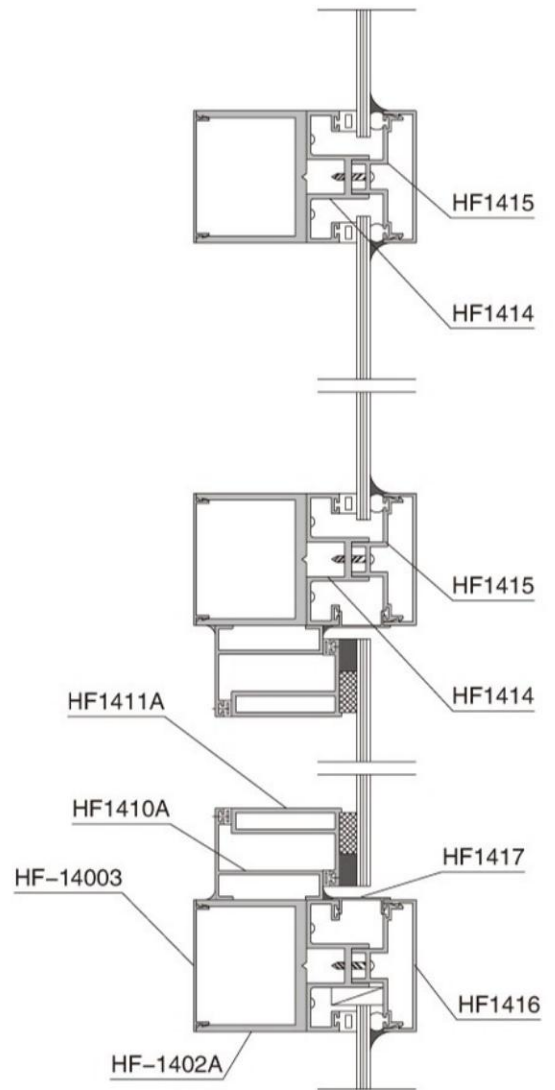

HF-1401B

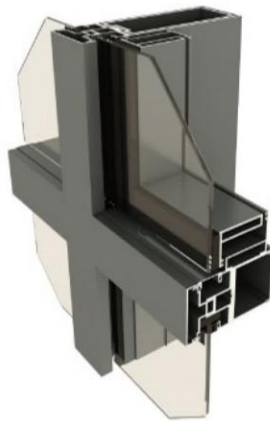
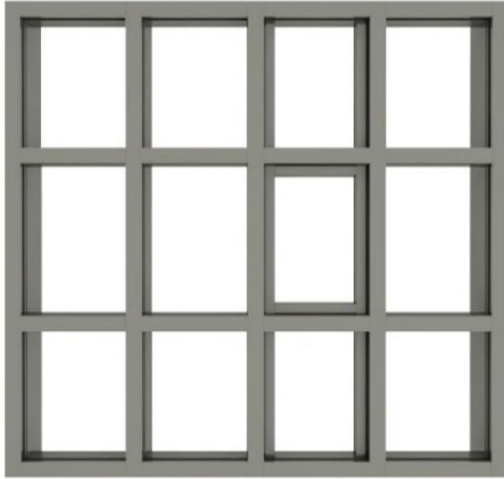
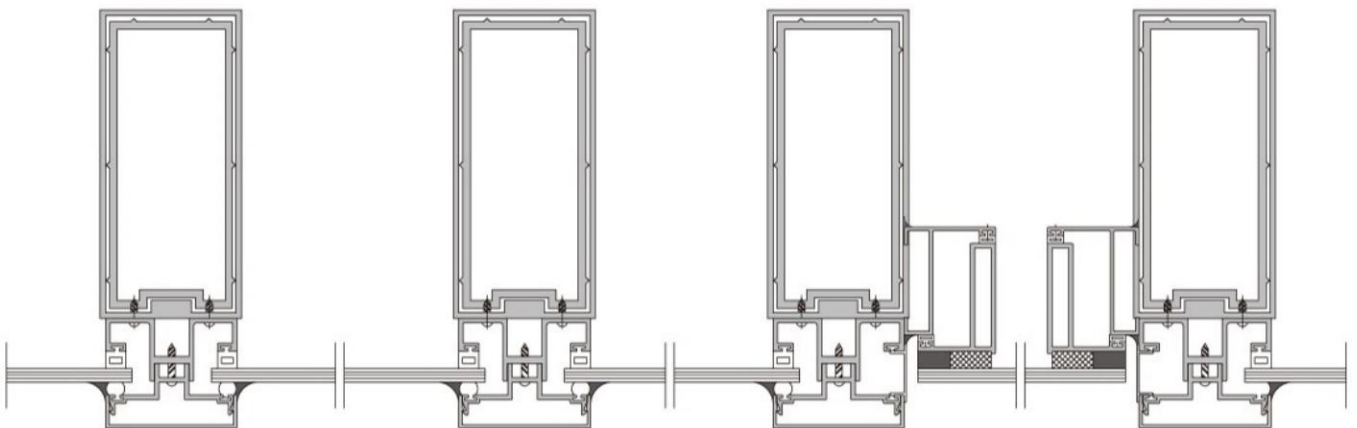

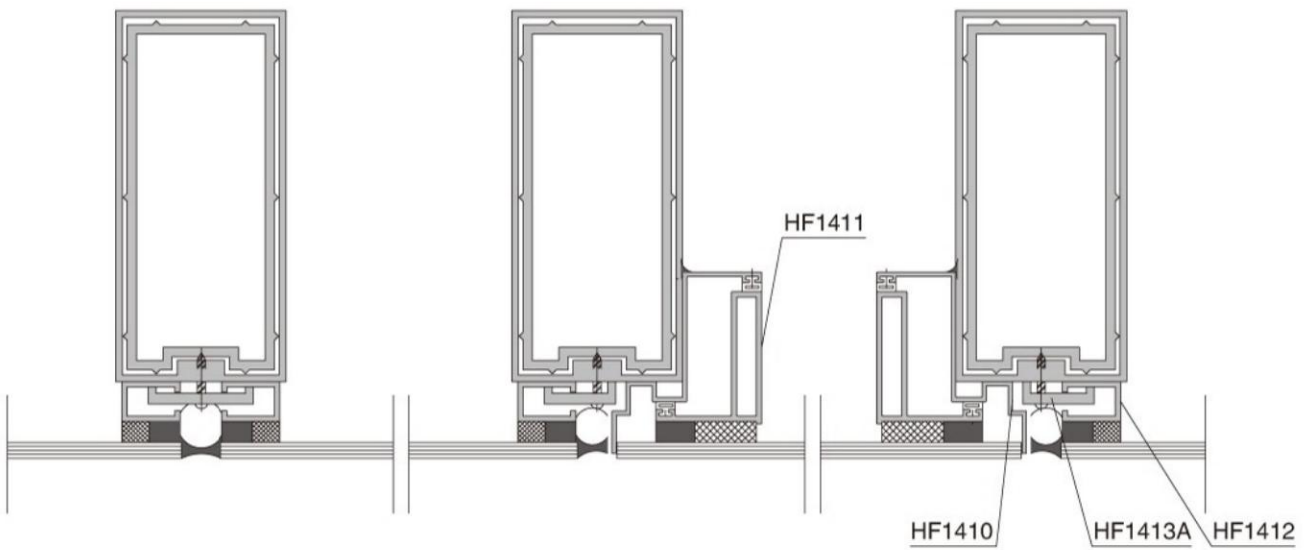
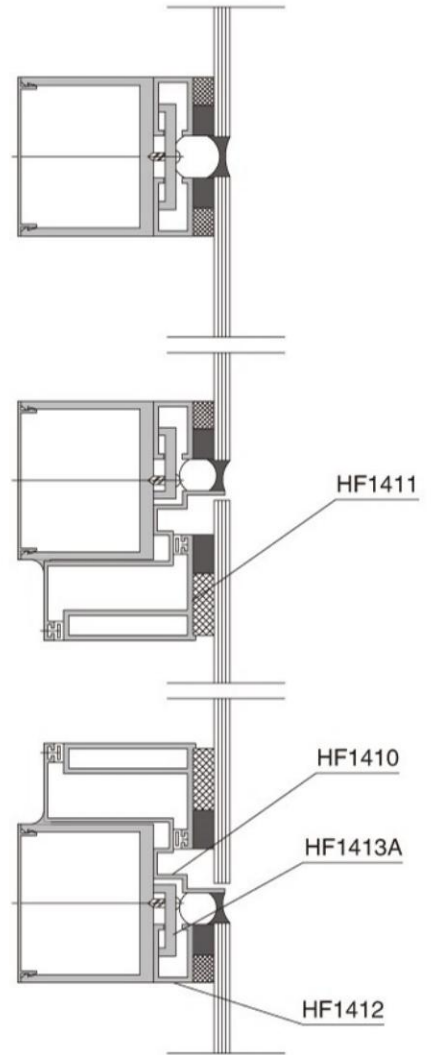

HF-1001 壁厚 (mm) 米重 (kg/m) 2.0 2.482 50 100 配SH-1002B	HF-1102 壁厚 (mm) 米重 (kg/m) 3.0 2.549 108 52 配HF-1106	HF-1406 壁厚 (mm) 米重 (kg/m) 3.0 2.146 53.9 86.8
HF-1001B 壁厚 (mm) 米重 (kg/m) 3.0 2.656 60 100	HF-1106 壁厚 (mm) 米重 (kg/m) 3.0 2.248 101.8 45.2	HF-1501 壁厚 (mm) 米重 (kg/m) 3.0 3.843 150 60 配HF-1406
HF-1001C 壁厚 (mm) 米重 (kg/m) 2.4 2.398 65 100 配HF-1002C	SH-1109B 壁厚 (mm) 米重 (kg/m) 3.5 2.968 103.5 58	HF-1601 壁厚 (mm) 米重 (kg/m) 3.0 4.007 160 60 配HF-1406
SH-1002B 壁厚 (mm) 米重 (kg/m) 2.0 1.344 45 83	HF-1201 壁厚 (mm) 米重 (kg/m) 3.0 3.352 60 120 配HF-1406	HF-12043 壁厚 (mm) 米重 (kg/m) 3.0 2.26 103 43
HF-1002C 壁厚 (mm) 米重 (kg/m) 3.0 1.999 59.2 94.2	HF-1401 壁厚 (mm) 米重 (kg/m) 3.0 3.679 60 140 配HF-1406	HF-12050 壁厚 (mm) 米重 (kg/m) 3.0 2.63 50 120 配HF-12043
HF-1101 壁厚 (mm) 米重 (kg/m) 2.5 1.429 52 75	HF-1401B 壁厚 (mm) 米重 (kg/m) 2.5 3.007 64.6 140.3 配SH-1402	HF-1801 壁厚 (mm) 米重 (kg/m) 5.0 6.67 180 73 配HF-1802
HF-1101B 壁厚 (mm) 米重 (kg/m) 3.0 3.038 65 110 配SH-1109B	SH-1402 壁厚 (mm) 米重 (kg/m) 3.5 3.548 133.5 59	HF-1802 壁厚 (mm) 米重 (kg/m) 3.5 4.2 159 62 HF-1802

图样重量为基材理论重量，客户可根据需要的厚度订购，实际重量以过磅时的重量为准。

1801-Q		HF-1003B		HF-1110	
壁厚 (mm)	米重 (kg/m)	壁厚 (mm)	米重 (kg/m)	壁厚 (mm)	米重 (kg/m)
3.0	4.56	2.0	1.218	2.0	1.671
1811-Q		HF-1104		HF-1111	
壁厚 (mm)	米重 (kg/m)	壁厚 (mm)	米重 (kg/m)	壁厚 (mm)	米重 (kg/m)
3.0	4.33	2.8	0.513	3.0	1.599
YZX-017		HF-1105		HF-1112	
壁厚 (mm)	米重 (kg/m)	壁厚 (mm)	米重 (kg/m)	壁厚 (mm)	米重 (kg/m)
2.5	2.49	2.3	0.298	1.5	0.286
YZX-018		HF-1006B		HF-1402A	
壁厚 (mm)	米重 (kg/m)	壁厚 (mm)	米重 (kg/m)	壁厚 (mm)	米重 (kg/m)
2.5	1.79	1.8	0.377	3.0	1.522
HF-1801B		HF-1106C		HF-1402B	
壁厚 (mm)	米重 (kg/m)	壁厚 (mm)	米重 (kg/m)	壁厚 (mm)	米重 (kg/m)
3.0	4.34	1.6	0.391	2.2	0.956
1004		SH-1106B		HF-1403	
壁厚 (mm)	米重 (kg/m)	壁厚 (mm)	米重 (kg/m)	壁厚 (mm)	米重 (kg/m)
2.0	0.172	1.6	0.375	1.1	0.23
HF-1102B		HF-1107		HF-1404	
壁厚 (mm)	米重 (kg/m)	壁厚 (mm)	米重 (kg/m)	壁厚 (mm)	米重 (kg/m)
2.0	1.417	10.0	1.011	1.5	0.313

图样重量为基材理论重量，客户可根据需要的厚度订购，实际重量以过磅时的重量为准。

HF-1404A		HF-1413		HF-1417	
壁厚 (mm) 米重 (kg/m)		壁厚 (mm) 米重 (kg/m)		壁厚 (mm) 米重 (kg/m)	
1.5 0.875		3.0 0.384		1.2 0.131	
HF-1405		HF-1413A		HF-1417A	
壁厚 (mm) 米重 (kg/m)		壁厚 (mm) 米重 (kg/m)		壁厚 (mm) 米重 (kg/m)	
1.5 0.545		3.0 0.294		1.2 0.171	
SH-1416A		HF-1414		HF-1803	
壁厚 (mm) 米重 (kg/m)		壁厚 (mm) 米重 (kg/m)		壁厚 (mm) 米重 (kg/m)	
1.2 0.74		2.0 0.923		3.0 1.74	
HF-1410		HF-1414A		HF-1804	
壁厚 (mm) 米重 (kg/m)		壁厚 (mm) 米重 (kg/m)		壁厚 (mm) 米重 (kg/m)	
1.6 0.611		2.0 1.157		2.0 0.43	
HF-1410-1		HF-1415		H1603	
壁厚 (mm) 米重 (kg/m)		壁厚 (mm) 米重 (kg/m)		壁厚 (mm) 米重 (kg/m)	
1.6 0.402		2.0 0.535		2.0 1.55	
HF-1412		HF-1415B		H1604	
壁厚 (mm) 米重 (kg/m)		壁厚 (mm) 米重 (kg/m)		壁厚 (mm) 米重 (kg/m)	
2.0 0.322		2.0 0.715		1.5 0.271	
HF-1412A		HF-1416		HF-1623	
壁厚 (mm) 米重 (kg/m)		壁厚 (mm) 米重 (kg/m)		壁厚 (mm) 米重 (kg/m)	
1.5 0.429		1.5 0.363		2.5 0.435	

图样重量为基材理论重量，客户可根据需要的厚度订购，实际重量以过磅时的重量为准。

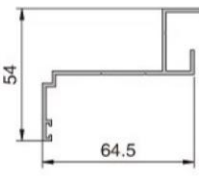
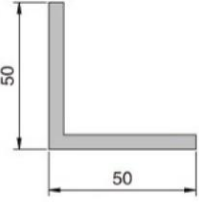
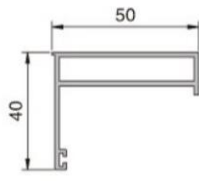
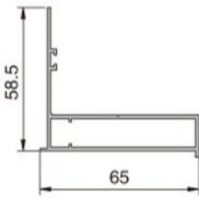
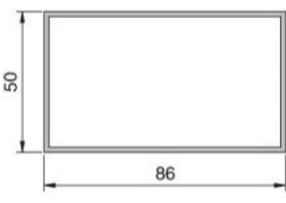
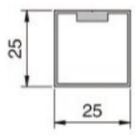
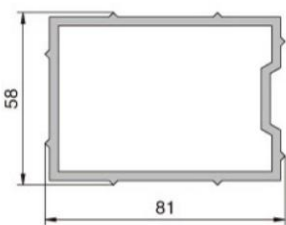
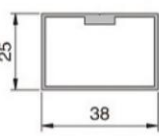
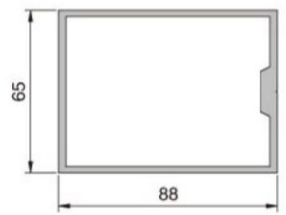
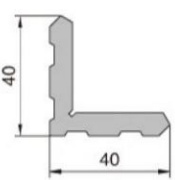
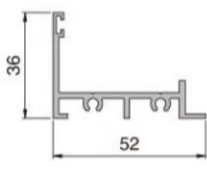
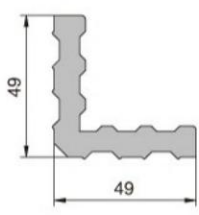
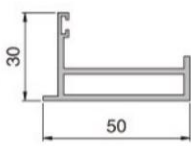
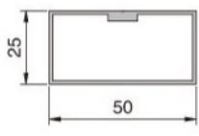
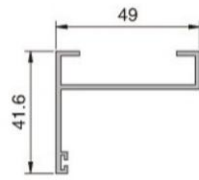
<table border="1"> <tr><td colspan="2">H078</td></tr> <tr><td>壁厚 (mm)</td><td>米重 (kg/m)</td></tr> <tr><td>1.5</td><td>0.581</td></tr> </table> 	H078		壁厚 (mm)	米重 (kg/m)	1.5	0.581	<table border="1"> <tr><td colspan="2">HF-5050</td></tr> <tr><td>壁厚 (mm)</td><td>米重 (kg/m)</td></tr> <tr><td>5.0</td><td>1.297</td></tr> </table> 	HF-5050		壁厚 (mm)	米重 (kg/m)	5.0	1.297	<table border="1"> <tr><td colspan="2">HF-1411</td></tr> <tr><td>壁厚 (mm)</td><td>米重 (kg/m)</td></tr> <tr><td>1.6</td><td>0.664</td></tr> </table> 	HF-1411		壁厚 (mm)	米重 (kg/m)	1.6	0.664
H078																				
壁厚 (mm)	米重 (kg/m)																			
1.5	0.581																			
HF-5050																				
壁厚 (mm)	米重 (kg/m)																			
5.0	1.297																			
HF-1411																				
壁厚 (mm)	米重 (kg/m)																			
1.6	0.664																			
<table border="1"> <tr><td colspan="2">H079</td></tr> <tr><td>壁厚 (mm)</td><td>米重 (kg/m)</td></tr> <tr><td>1.5</td><td>0.832</td></tr> </table> 	H079		壁厚 (mm)	米重 (kg/m)	1.5	0.832	<table border="1"> <tr><td colspan="2">HF-5086</td></tr> <tr><td>壁厚 (mm)</td><td>米重 (kg/m)</td></tr> <tr><td>1.8</td><td>1.301</td></tr> </table> 	HF-5086		壁厚 (mm)	米重 (kg/m)	1.8	1.301							
H079																				
壁厚 (mm)	米重 (kg/m)																			
1.5	0.832																			
HF-5086																				
壁厚 (mm)	米重 (kg/m)																			
1.8	1.301																			
<table border="1"> <tr><td colspan="2">HF-2525K</td></tr> <tr><td>壁厚 (mm)</td><td>米重 (kg/m)</td></tr> <tr><td>1.2</td><td>0.396</td></tr> </table> 	HF-2525K		壁厚 (mm)	米重 (kg/m)	1.2	0.396	<table border="1"> <tr><td colspan="2">HF-8156</td></tr> <tr><td>壁厚 (mm)</td><td>米重 (kg/m)</td></tr> <tr><td>3.0</td><td>2.163</td></tr> </table> 	HF-8156		壁厚 (mm)	米重 (kg/m)	3.0	2.163							
HF-2525K																				
壁厚 (mm)	米重 (kg/m)																			
1.2	0.396																			
HF-8156																				
壁厚 (mm)	米重 (kg/m)																			
3.0	2.163																			
<table border="1"> <tr><td colspan="2">HF-3825K</td></tr> <tr><td>壁厚 (mm)</td><td>米重 (kg/m)</td></tr> <tr><td>1.2</td><td>0.46</td></tr> </table> 	HF-3825K		壁厚 (mm)	米重 (kg/m)	1.2	0.46	<table border="1"> <tr><td colspan="2">HF-8860</td></tr> <tr><td>壁厚 (mm)</td><td>米重 (kg/m)</td></tr> <tr><td>2.5</td><td>2.38</td></tr> </table> 	HF-8860		壁厚 (mm)	米重 (kg/m)	2.5	2.38							
HF-3825K																				
壁厚 (mm)	米重 (kg/m)																			
1.2	0.46																			
HF-8860																				
壁厚 (mm)	米重 (kg/m)																			
2.5	2.38																			
<table border="1"> <tr><td colspan="2">HF-4040</td></tr> <tr><td>壁厚 (mm)</td><td>米重 (kg/m)</td></tr> <tr><td>7.6</td><td>1.33</td></tr> </table> 	HF-4040		壁厚 (mm)	米重 (kg/m)	7.6	1.33	<table border="1"> <tr><td colspan="2">MB15008 开启框</td></tr> <tr><td>壁厚 (mm)</td><td>米重 (kg/m)</td></tr> <tr><td>2.0</td><td>0.64</td></tr> </table> 	MB15008 开启框		壁厚 (mm)	米重 (kg/m)	2.0	0.64							
HF-4040																				
壁厚 (mm)	米重 (kg/m)																			
7.6	1.33																			
MB15008 开启框																				
壁厚 (mm)	米重 (kg/m)																			
2.0	0.64																			
<table border="1"> <tr><td colspan="2">HF-4949</td></tr> <tr><td>壁厚 (mm)</td><td>米重 (kg/m)</td></tr> <tr><td>11.5</td><td>2.148</td></tr> </table> 	HF-4949		壁厚 (mm)	米重 (kg/m)	11.5	2.148	<table border="1"> <tr><td colspan="2">MB15009 开启扇</td></tr> <tr><td>壁厚 (mm)</td><td>米重 (kg/m)</td></tr> <tr><td>2.0</td><td>1.036</td></tr> </table> 	MB15009 开启扇		壁厚 (mm)	米重 (kg/m)	2.0	1.036							
HF-4949																				
壁厚 (mm)	米重 (kg/m)																			
11.5	2.148																			
MB15009 开启扇																				
壁厚 (mm)	米重 (kg/m)																			
2.0	1.036																			
<table border="1"> <tr><td colspan="2">HF-5025K</td></tr> <tr><td>壁厚 (mm)</td><td>米重 (kg/m)</td></tr> <tr><td>1.2</td><td>0.538</td></tr> </table> 	HF-5025K		壁厚 (mm)	米重 (kg/m)	1.2	0.538	<table border="1"> <tr><td colspan="2">HF-1410A</td></tr> <tr><td>壁厚 (mm)</td><td>米重 (kg/m)</td></tr> <tr><td>1.6</td><td>0.52</td></tr> </table> 	HF-1410A		壁厚 (mm)	米重 (kg/m)	1.6	0.52							
HF-5025K																				
壁厚 (mm)	米重 (kg/m)																			
1.2	0.538																			
HF-1410A																				
壁厚 (mm)	米重 (kg/m)																			
1.6	0.52																			

图样重量为基材理论重量，客户可根据需要的厚度订购，实际重量以过磅时的重量为准。